



Remote control

FRP 15

099-008045-EW501

Observe additional system documents!

16.08.2012

Register now!
For your benefit
Jetzt Registrieren
und Profitieren!

www.ewm-group.com



General instructions

CAUTION



Read the operating instructions!

The operating instructions provide an introduction to the safe use of the products.

- Read the operating instructions for all system components!
- Observe accident prevention regulations!
- Observe all local regulations!
- Confirm with a signature where appropriate.

NOTE



In the event of queries on installation, commissioning, operation or special conditions at the installation site, or on usage, please contact your sales partner or our customer service department on +49 2680 181-0.

A list of authorised sales partners can be found at www.ewm-group.com.

Liability relating to the operation of this equipment is restricted solely to the function of the equipment. No other form of liability, regardless of type, shall be accepted. This exclusion of liability shall be deemed accepted by the user on commissioning the equipment.

The manufacturer is unable to monitor whether or not these instructions or the conditions and methods are observed during installation, operation, usage and maintenance of the equipment.

An incorrectly performed installation can result in material damage and injure persons as a result. For this reason, we do not accept any responsibility or liability for losses, damages or costs arising from incorrect installation, improper operation or incorrect usage and maintenance or any actions connected to this in any way.

1 Contents

1	Contents	3
2	Safety instructions	4
2.1	Notes on the use of these operating instructions	4
2.2	Explanation of icons.....	5
2.3	General	6
2.4	Transport.....	8
2.4.1	Scope of delivery.....	8
2.5	Ambient conditions.....	8
2.5.1	In operation.....	8
2.5.2	Transport and storage	8
3	Intended use	9
3.1	Use and operation solely with the following machines	9
3.2	Documents which also apply	10
3.2.1	Warranty	10
3.2.2	Declaration of Conformity.....	10
3.2.3	Welding in environments with increased electrical hazards.....	10
3.2.4	Service documents (spare parts and circuit diagrams).....	10
4	Machine description – quick overview	11
5	Design and function	12
5.1	Establishing the connections	12
5.2	Functional characteristics	13
5.3	Circuit diagram.....	13
6	Maintenance, care and disposal	14
6.1	General	14
6.2	Maintenance work, intervals	14
6.2.1	Monthly maintenance tasks.....	14
6.3	Maintenance work.....	14
6.4	Disposing of equipment	14
6.4.1	Manufacturer's declaration to the end user.....	15
6.5	Meeting the requirements of RoHS	15
7	Technical data	16
8	Accessories	16
8.1	Connection and extension cables.....	16
9	Appendix A	17
9.1	Overview of EWM branches	17

2 Safety instructions

2.1 Notes on the use of these operating instructions



DANGER

Working or operating procedures which must be closely observed to prevent imminent serious and even fatal injuries.

- Safety notes include the "DANGER" keyword in the heading with a general warning symbol.
- The hazard is also highlighted using a symbol on the edge of the page.



WARNING

Working or operating procedures which must be closely observed to prevent serious and even fatal injuries.

- Safety notes include the "WARNING" keyword in the heading with a general warning symbol.
- The hazard is also highlighted using a symbol in the page margin.



CAUTION

Working or operating procedures which must be closely observed to prevent possible minor personal injury.

- The safety information includes the "CAUTION" keyword in its heading with a general warning symbol.
- The risk is explained using a symbol on the edge of the page.

CAUTION

Working and operating procedures which must be followed precisely to avoid damaging or destroying the product.

- The safety information includes the "CAUTION" keyword in its heading without a general warning symbol.
- The hazard is explained using a symbol at the edge of the page.

NOTE













Special technical points which users must observe.

- Notes include the "NOTE" keyword in the heading without a general warning symbol.

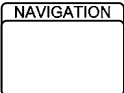
Instructions and lists detailing step-by-step actions for given situations can be recognised via bullet points, e.g.:

- Insert the welding current lead socket into the relevant socket and lock.

2.2 Explanation of icons

Symbol	Description
	Press
	Do not press
	Turn
	Switch
	Switch off machine
	Switch on machine
	ENTER (enter the menu)
	NAVIGATION (Navigating in the menu)
	EXIT (Exit the menu)
	Time display (example: wait 4s/press)
	Interruption in the menu display (other setting options possible)
	Tool not required/do not use
	Tool required/use

2.3 General

DANGER



Electric shock!

Welding machines use high voltages which can result in potentially fatal electric shocks and burns on contact. Even low voltages can cause you to get a shock and lead to accidents.

- Do not touch any live parts in or on the machine!
- Connection cables and leads must be free of faults!
- Switching off alone is not sufficient!
- Place welding torch and stick electrode holder on an insulated surface!
- The unit should only be opened by specialist staff after the mains plug has been unplugged!
- Only wear dry protective clothing!
- Wait for 4 minutes until the capacitors have discharged!



Electromagnetic fields!

The power source may cause electrical or electromagnetic fields to be produced which could affect the correct functioning of electronic equipment such as IT or CNC devices, telecommunication lines, power cables, signal lines and pacemakers.

- Observe the maintenance instructions! (see Maintenance and Testing chapter)
- Unwind welding leads completely!
- Shield devices or equipment sensitive to radiation accordingly!
- The correct functioning of pacemakers may be affected (obtain advice from a doctor if necessary).



Validity of this document!

This document describes an accessory and is only valid in combination with the operating instructions for the power source being used (welding machine)!

- Read the operating instructions, in particular the safety instructions for the power source (welding machine)!

WARNING



Risk of accidents if these safety instructions are not observed!

Non-observance of these safety instructions is potentially fatal!

- Carefully read the safety information in this manual!
- Observe the accident prevention regulations in your country.
- Inform persons in the working area that they must observe the regulations!



Fire hazard!

Flames may arise as a result of the high temperatures, stray sparks, glowing-hot parts and hot slag produced during the welding process.

Stray welding currents can also result in flames forming!

- Check for fire hazards in the working area!
- Do not carry any easily flammable objects such as matches or lighters.
- Keep appropriate fire extinguishing equipment to hand in the working area!
- Thoroughly remove any residue of flammable substances from the workpiece before starting welding.
- Only continue work on welded workpieces once they have cooled down.
Do not allow to come into contact with flammable material!
- Connect welding leads correctly!

 **WARNING****Risk of injury due to radiation or heat!****Arc radiation results in injury to skin and eyes.****Contact with hot workpieces and sparks results in burns.**

- Use welding shield or welding helmet with the appropriate safety level (depending on the application)!
- Wear dry protective clothing (e.g. welding shield, gloves, etc.) according to the relevant regulations in the country in question!
- Protect persons not involved in the work against arc beams and the risk of glare using safety curtains!

**Hazards due to improper usage!****Hazards may arise for persons, animals and material objects if the equipment is not used correctly. No liability is accepted for any damages arising from improper usage!**

- The equipment must only be used in line with proper usage and by trained or expert staff!
- Do not modify or convert the equipment improperly!

 **CAUTION****Noise exposure!****Noise exceeding 70 dBA can cause permanent hearing damage!**

- Wear suitable ear protection!
- Persons located within the working area must wear suitable ear protection!

CAUTION**Obligations of the operator!****The respective national directives and laws must be observed for operation of the machine!**

- National implementation of the framework directive (89/391/EWG), as well as the associated individual directives.
- In particular, directive (89/655/EWG), on the minimum regulations for safety and health protection when staff members use equipment during work.
- The regulations regarding work safety and accident prevention for the respective country.
- Setting up and operating the machine according to IEC 60974-9.
- Check at regular intervals that users are working in a safety-conscious way.
- Regular checks of the machine according to IEC 60974-4.

**Damage due to the use of non-genuine parts!****The manufacturer's warranty becomes void if non-genuine parts are used!**

- Only use system components and options (power sources, welding torches, electrode holders, remote controls, spare parts and replacement parts, etc.) from our range of products!
- Only insert and lock accessory components into the relevant connection socket when the machine is switched off.

**Trained personnel!****Commissioning is reserved for persons who have the relevant expertise of working with arc welding machines.**

2.4 Transport

CAUTION



Damage due to supply lines not being disconnected!
During transport, supply lines which have not been disconnected (mains supply leads, control leads, etc.) may cause hazards such as connected equipment tipping over and injuring persons!

- Disconnect supply lines!

2.4.1 Scope of delivery

The delivery is checked and packaged carefully before dispatch, however it is not possible to exclude the possibility of damage during transit.

Receiving inspection

- Check that the delivery is complete using the delivery note!

In the event of damage to the packaging

- Check the delivery for damage (visual inspection)!

In the event of complaints

If the delivery has been damaged during transport:

- Please contact the last haulier immediately!
- Keep the packaging (for possible checking by the haulier or for the return shipment).

Packaging for returns

If possible, please use the original packaging and the original packaging material. If you have any queries on packaging and protection during transport, please contact your supplier.

2.5 Ambient conditions

CAUTION



Equipment damage due to dirt accumulation!
Unusually high quantities of dust, acid, corrosive gases or substances may damage the equipment.

- Avoid high volumes of smoke, vapour, oil vapour and grinding dust!
- Avoid ambient air containing salt (sea air)!

2.5.1 In operation

Temperature range of the ambient air:

- -20 °C to +40 °C

Relative air humidity:

- Up to 50% at 40 °C
- Up to 90% at 20 °C

2.5.2 Transport and storage

Storage in an enclosed space, temperature range of the ambient air:

- -25 °C to +55 °C

Relative air humidity

- Up to 90% at 20 °C

3 Intended use

 **WARNING****Hazards due to improper usage!**

Hazards may arise for persons, animals and material objects if the equipment is not used correctly. No liability is accepted for any damages arising from improper usage!

- The equipment must only be used in line with proper usage and by trained or expert staff!
- Do not modify or convert the equipment improperly!

3.1 Use and operation solely with the following machines

This remote control is designed for welding machines of the Microplasma series and offers a variety of settings.

- Microplasma 20 / 50 / 120

3.2 Documents which also apply

3.2.1 Warranty

NOTE



For further information, please see the accompanying supplementary sheets "Machine and Company Data, Maintenance and Testing, Warranty"!

3.2.2 Declaration of Conformity



The designated machine conforms to EC Directives and standards in terms of its design and construction:

- EC Low Voltage Directive (2006/95/EC),
- EC EMC Directive (2004/108/EC),

This declaration shall become null and void in the event of unauthorised modifications, improperly conducted repairs, non-observance of the deadlines for the repetition test and / or non-permitted conversion work not specifically authorised by the manufacturer.

The original copy of the declaration of conformity is enclosed with the unit.

3.2.3 Welding in environments with increased electrical hazards



In compliance with IEC / DIN EN 60974, VDE 0544 the machines can be used in environments with an increased electrical hazard.

3.2.4 Service documents (spare parts and circuit diagrams)



DANGER



Do not carry out any unauthorised repairs or modifications!

To avoid injury and equipment damage, the unit must only be repaired or modified by specialist, skilled persons!

The warranty becomes null and void in the event of unauthorised interference.

- Appoint only skilled persons for repair work (trained service personnel)!

Original copies of the circuit diagrams are enclosed with the unit.

Spare parts can be obtained from the relevant authorised dealer.

4 Machine description – quick overview

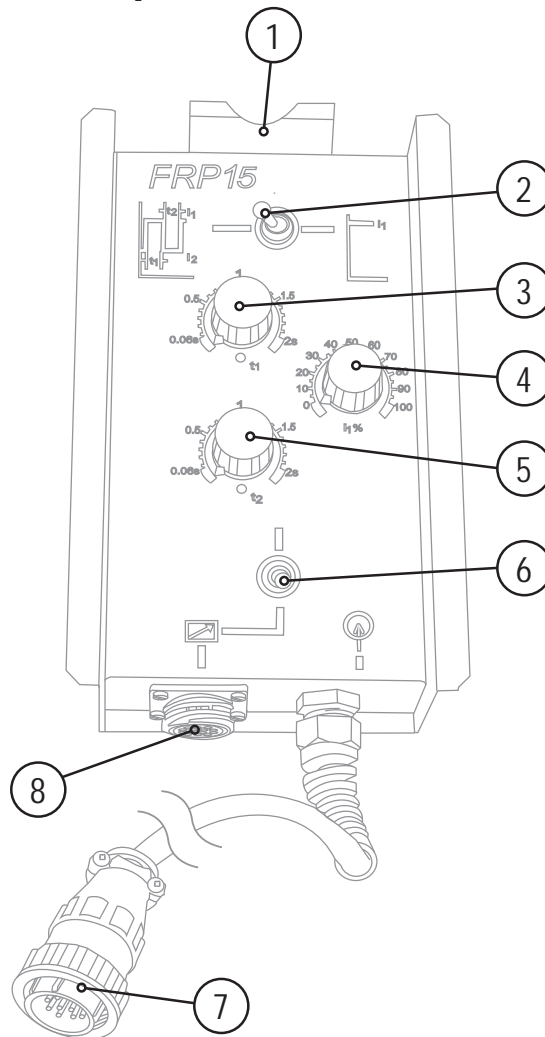

Figure 4-1

Item	Symbol	Description
1		Holder for suspending the machine
2		Pulsing changeover switch ON/OFF
3		Pulse current time rotary knob (t_1) Select a pulse current time from 0.06–2 s
4		Main current rotary knob Infinite adjustment of the main current from min. to max. value
5		Basic current time rotary knob (t_2) Select a basic current time from 0.06–2 s
6		Changeover switch Operation of another remote control
7		Connection socket, 14-pole Remote control connection
8		14-pole connection socket Additional remote control connection socket

5 Design and function

NOTE



Observe documentation of other system components when connecting!

5.1 Establishing the connections

CAUTION



Damage to the machine due to improper connection!

The remote controls have been developed to be connected to welding machines or wire feed units only. Connecting them to other machines may cause damage to the machines!

- Observe the operating instructions for the welding machine or wire feed unit!
- Switch off the welding machine before connecting!

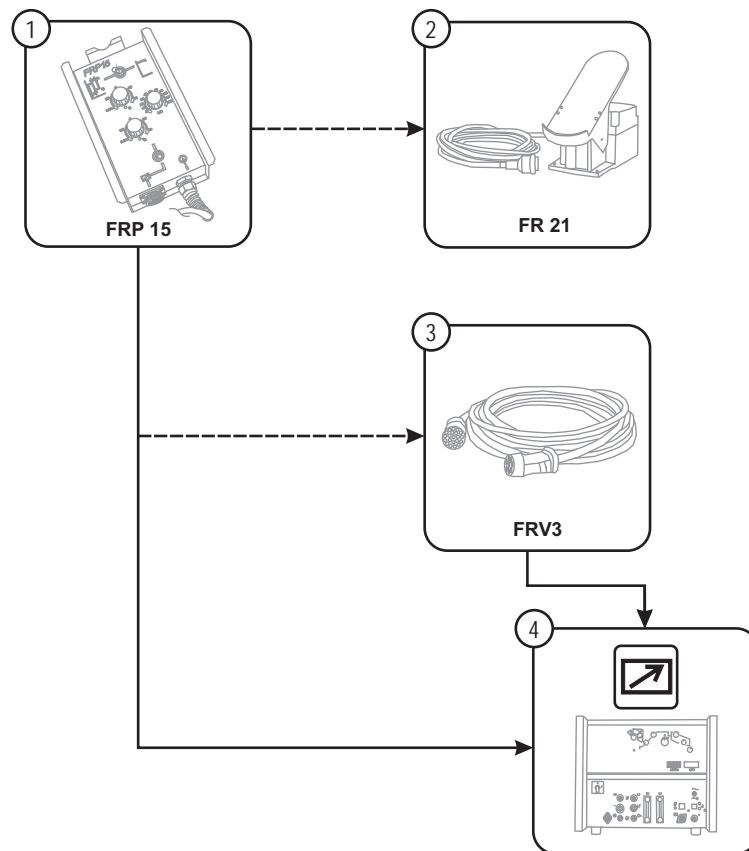

Figure 5-1

Item	Symbol	Description
1		Manual remote control
2		Foot-operated remote control
3		Extension cable for 14-pole connections
4		Power source

- Switch off the welding machine
- Insert the male connector plug (socket) into the remote control connection socket and lock by turning to the right.
- Insert the male connector plug (pin) into the remote control connection socket of the welding machine and lock by turning to the right.

5.2 Functional characteristics

The pulse current level corresponds to the welding current I_1 set at the welding machine and can be infinitely adjusted at the remote control potentiometer, in a percentage value of the main current at the machine. The basic current I_2 is set in a percentage value of I_1 at the machine front panel.

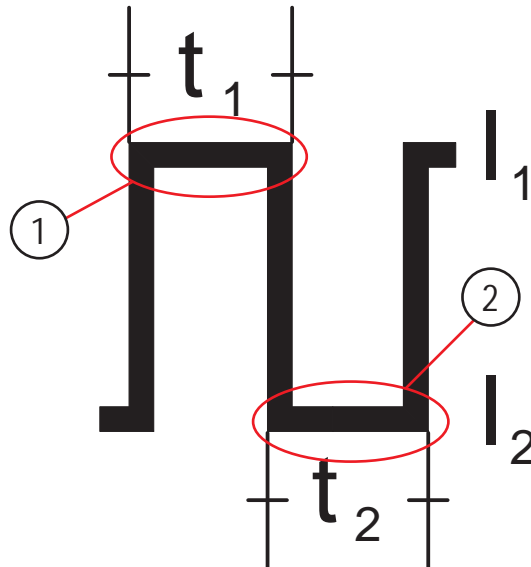

Figure 5-2

Item	Symbol	Description
1		Pulse current time
2		Basic current time

5.3 Circuit diagram

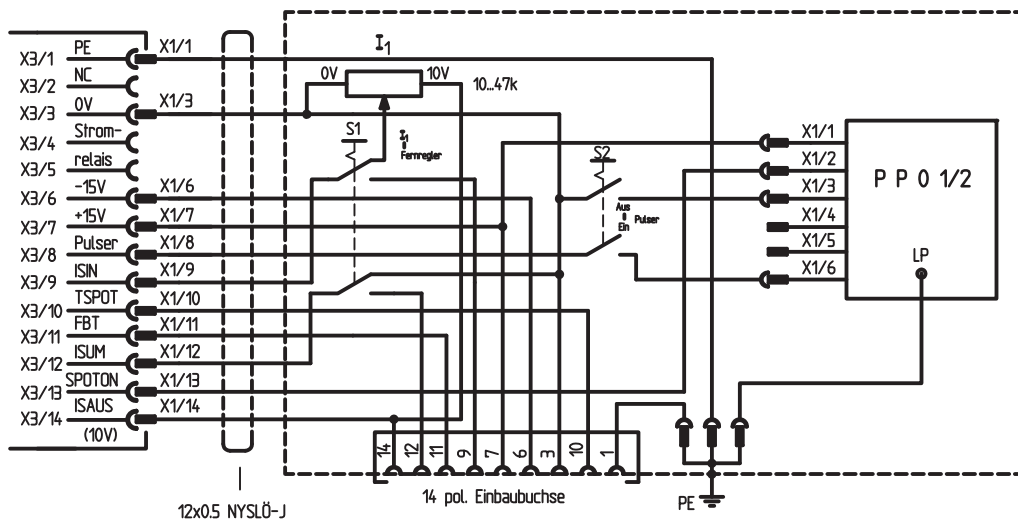

Figure 5-3

6 Maintenance, care and disposal

6.1 General

When used in the specified environmental conditions and under normal operating conditions, this machine is largely maintenance-free and requires a minimum of care.

There are some points, which should be observed, to guarantee fault-free operation of your welding machine. Among these are regular cleaning and checking as described below, depending on the pollution level of the environment and the length of time the unit is in use.

6.2 Maintenance work, intervals

6.2.1 Monthly maintenance tasks

- Check control leads and their strain relief for damage.
- Carry out functional test of operating, signalling, safety and/or adjustment devices.
- Other, general condition

6.3 Maintenance work

DANGER



Do not carry out any unauthorised repairs or modifications!

To avoid injury and equipment damage, the unit must only be repaired or modified by specialist, skilled persons!

The warranty becomes null and void in the event of unauthorised interference.

- Appoint only skilled persons for repair work (trained service personnel)!

Repair and maintenance work may only be performed by qualified authorised personnel; otherwise the right to claim under warranty is void. In all service matters, always consult the dealer who supplied the machine. Return deliveries of defective equipment subject to warranty may only be made through your dealer. When replacing parts, use only original spare parts. When ordering spare parts, please quote the machine type, serial number and item number of the machine, as well as the type designation and item number of the spare part.

6.4 Disposing of equipment

NOTE



Proper disposal!

The machine contains valuable raw materials, which should be recycled, and electronic components, which must be disposed of.

- Do not dispose of in household waste!
- Observe the local regulations regarding disposal!



6.4.1 Manufacturer's declaration to the end user

- According to European provisions (guideline 2002/96/EG of the European Parliament and the Council of January, 27th 2003), used electric and electronic equipment may no longer be placed in unsorted municipal waste. It must be collected separately. The symbol depicting a waste container on wheels indicates that the equipment must be collected separately.
This machine is to be placed for disposal or recycling in the waste separation systems provided for this purpose.
- According to German law (law governing the distribution, taking back and environmentally correct disposal of electric and electronic equipment (ElektroG) from 16.03.2005), used machines are to be placed in a collection system separate from unsorted municipal waste. The public waste management utilities (communities) have created collection points at which used equipment from private households can be disposed of free of charge.
- Information about giving back used equipment or about collections can be obtained from the respective municipal administration office.
- EWM participates in an approved waste disposal and recycling system and is registered in the Used Electrical Equipment Register (EAR) under number WEEE DE 57686922.
- In addition to this, returns are also possible throughout Europe via EWM sales partners.

6.5 Meeting the requirements of RoHS

We, EWM HIGHTEC Welding GmbH Mündersbach, hereby confirm that all products supplied by us which are affected by the RoHS Directive, meet the requirements of the RoHS (Directive 2002/95/EC).

7 Technical data

Interface	14-pole
Dimensions L x W x H in mm	270 x 145 x 75
Weight in kg	2,3

8 Accessories

8.1 Connection and extension cables

Type	Designation	Item no.
FRV3	Extension/connecting cable	092-000005-00003
FR21 14POL 5M	Foot-operated remote control, current	094-000051-00000

9 Appendix A

9.1 Overview of EWM branches

Headquarters

EWM HIGHTEC WELDING GmbH
Dr. Günter-Henle-Straße 8
56271 Mündersbach · Germany
Tel: +49 2680 181-0 · Fax: -244
www.ewm-group.com · info@ewm-group.com

Technology centre

EWM HIGHTEC WELDING GmbH
Forststr. 7-13
56271 Mündersbach · Germany
Tel: +49 2680 181-0 · Fax: -144
www.ewm-group.com · info@ewm-group.com



Production, Sales and Service

EWM HIGHTEC WELDING GmbH
Dr. Günter-Henle-Straße 8
56271 Mündersbach · Germany
Tel: +49 2680 181-0 · Fax: -244
www.ewm-group.com · info@ewm-group.com

EWM HIGHTEC WELDING s.r.o.
Tr. 9. kvetna 718 / 31
407 53 Jiríkov · Czech Republic
Tel: +420 412 358-551 · Fax: -504
www.ewm-jiríkov.cz · info@ewm-jiríkov.cz

EWM HIGHTEC WELDING (Kunshan) Ltd.
10 Yuanshan Road, Kunshan · New & High-tech Industry Development Zone
Kunshan · Jiangsu · 215300 · People's Republic of China
Tel: +86 512 57867-188 · Fax: -182
www.ewm-kunshan.cn · info@ewm-kunshan.cn

Sales and Service Germany

EWM HIGHTEC WELDING GmbH
Vertriebs- und Technologiezentrum
Grünauer Fenn 4
14712 Rathenow · Tel: +49 3385 49402-0 · Fax: -20
www.ewm-rathenow.de · info@ewm-rathenow.de

EWM HIGHTEC WELDING GmbH
Eiserfelder Straße 300
57080 Siegen · Tel: +49 271 3878103-0 · Fax: -9
www.ewm-siegen.de · info@ewm-siegen.de

EWM HIGHTEC WELDING GmbH
Lindenstraße 1a
38723 Seesen-Rhüden · Tel: +49 5384 90798-0 · Fax: -20
www.ewm-seesen.de · info@ewm-seesen.de

EWM HIGHTEC WELDING GmbH
Vertriebs- und Technologiezentrum
Draisstraße 2a
69469 Weinheim · Tel: +49 6201 84557-0 · Fax: -20
www.ewm-weinheim.de · info@ewm-weinheim.de

EWM HIGHTEC WELDING GmbH
Sachsstraße 28
50259 Pulheim · Tel: +49 2234 697-047 · Fax: -048
www.ewm-pulheim.de · info@ewm-pulheim.de

EWM Schweißtechnik Handels GmbH
Rittergasse 1
89143 Blaubeuren · Tel: +49 7344 9191-75 · Fax: -77
www.ewm-blaubeuren.de · info@ewm-blaubeuren.de

EWM HIGHTEC WELDING GmbH
In der Florinskaul 14-16
56218 Mülheim-Kärlich · Tel: +49 261 988898-0 · Fax: -20
www.ewm-muelheim-kaerlich.de · info@ewm-muelheim-kaerlich.de

EWM Schweißtechnik Handels GmbH
Heinkelstraße 8
89231 Neu-Ulm · Tel: +49 731 7047939-0 · Fax: -15
www.ewm-neu-ulm.de · info@ewm-neu-ulm.de

EWM HIGHTEC WELDING GmbH
Sälzerstr. 20
56235 Ransbach-Baumbach · Tel: +49 261 2623 9276-0 · Fax: -244
www.ewm-ransbach-baumbach.de · info@ewm-ransbach-baumbach.de

Sales and Service International

EWM HIGHTEC WELDING GmbH
Fichtenweg 1
4810 Gmunden · Austria · Tel: +43 7612 778 02-0 · Fax: -20
www.ewm-gmunden.at · info@ewm-gmunden.at

EWM HIGHTEC WELDING Sales s.r.o. / Prodejní a poradenské centrum
Tyršova 2106
256 01 Benešov u Prahy · Czech Republic
Tel: +420 317 729-517 · Fax: -712
www.ewm-benesov.cz · info@ewm-benesov.cz

EWM HIGHTEC WELDING UK Ltd.
Unit 2B Coopies Way · Coopies Lane Industrial Estate
Morpeth · Northumberland · NE61 6JN · Great Britain
Tel: +44 1670 505875 · Fax: -514305
www.ewm-morpeth.co.uk · info@ewm-morpeth.co.uk

EWM HIGHTEC WELDING FZCO / Regional Office Middle East
LOB 21 G 16 · P.O. Box 262851
Jebel Ali Free Zone · Dubai, UAE · United Arab Emirates
Tel: +971 48870-322 · Fax: -323
www.ewm-dubai.ae · info@ewm-dubai.ae

EWM HIGHTEC WELDING (Kunshan) Ltd.
10 Yuanshan Road, Kunshan · New & High-tech Industry Development Zone
Kunshan · Jiangsu · 215300 · People's Republic of China
Tel: +86 512 57867-188 · Fax: -182
www.ewm-kunshan.cn · info@ewm-kunshan.cn

